

Technical Specification

Mechanical failing load: 8.9kN

Low frequency dry flashover voltage:
20kV

Low frequency wet flashover voltage:

Vertical: 8kV

Horizontal: 10kV

Main Dimensions

H: 54mm D: 57mm R: 11mm

d1: 44mm d2: 17.5mm

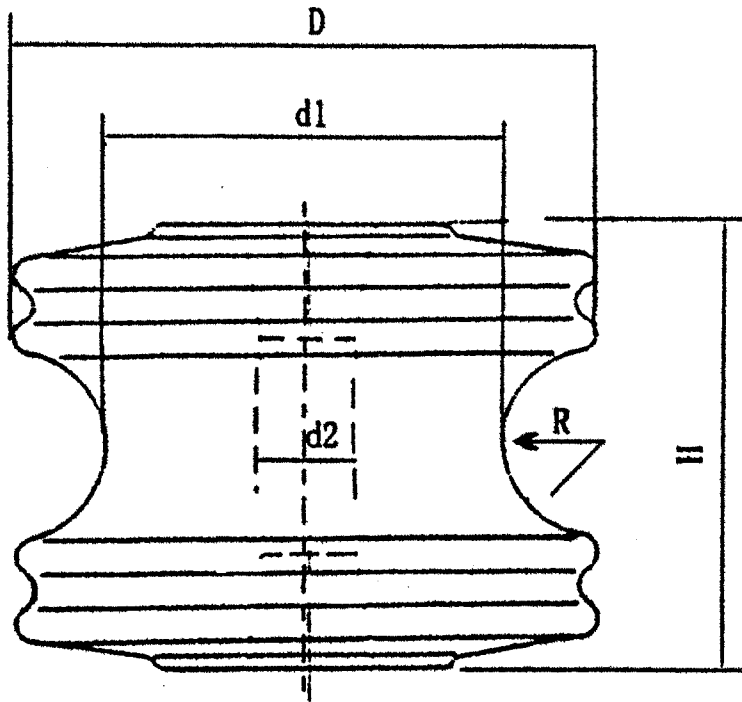

ANSI53-1	2335310	
Spool Porcelain Insulator	WEIGHT	UNIT
	0.2KG	MM
ASSEMBLY DRAWING	Newell-PSN	